



Butterflies

1



Let's go and look for butterflies.
You can find them if you look
out for them.

2



Butterflies can be black and
white or many colours.

3

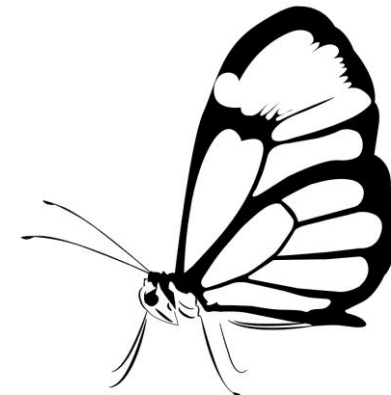

Butterflies rest with wings together
like this.

4



A butterfly lays an egg on a leaf.
After some time a little caterpillar
comes out of the egg.

5

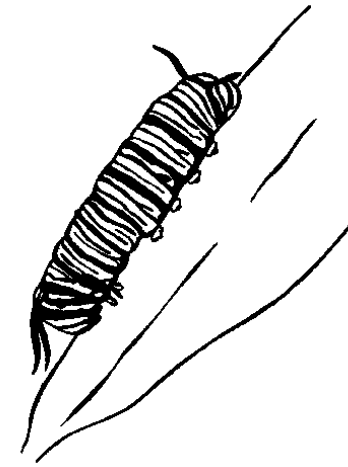

The caterpillar eats and eats. It
gets very fat.

6

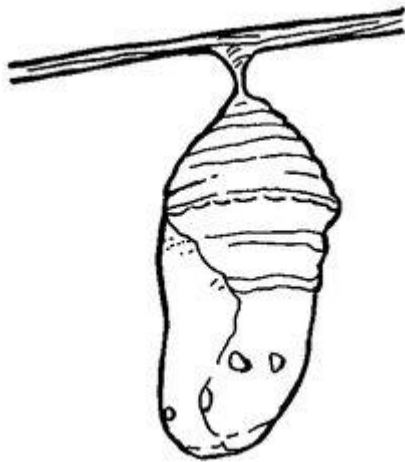

The caterpillar makes a little
home and goes to sleep.

7



When the caterpillar wakes up it is
a butterfly.

8

Counting Ants

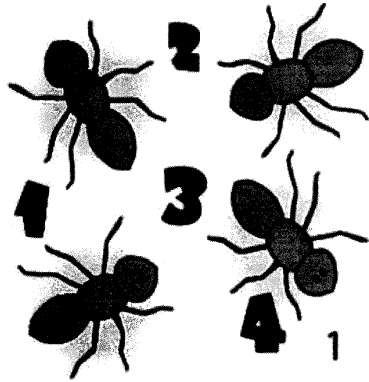

One, two, three, four

1

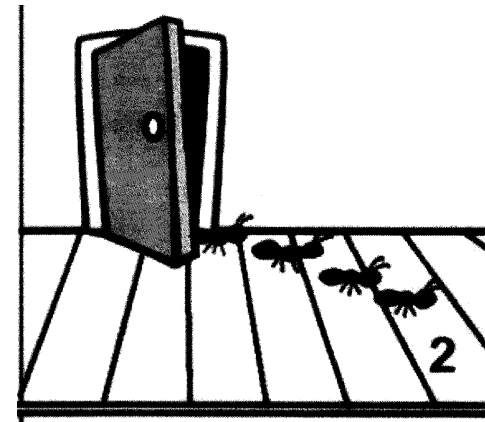

I see ants on the floor.

2

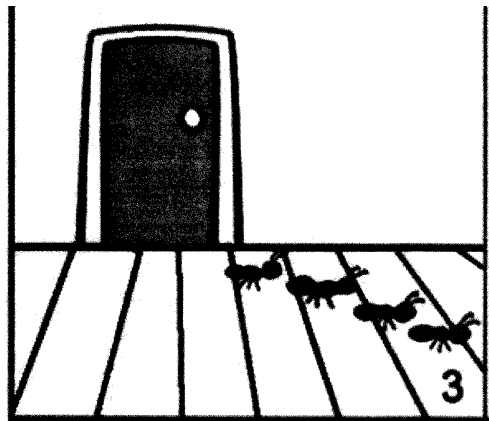

Hurry up and shut the door

3



4

We don't want any more.

4

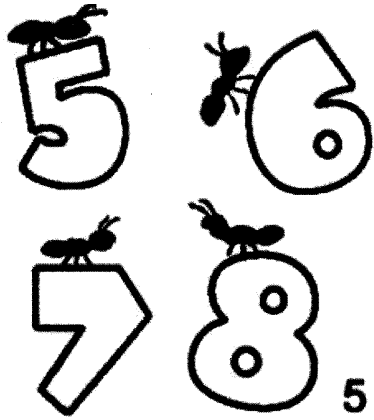

Five, six, seven, eight

5



going up the garden gate.

6



Nine, ten and eleven

7



Four fell off and now there are seven.

Level 5

8

Ladybug

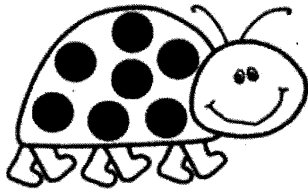

I can help

Level 5

1



I can help look after my pets.

2

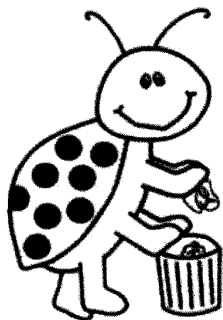

I can help to clean up.

3



I can help by making a card for someone who is sick.

4

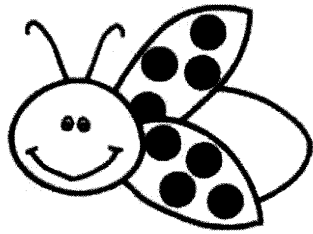

I can go and talk to someone who is sad.

5



I can draw a picture for someone.

6



I can give someone flowers.

Level 5

7



I can put my things away.

www.daniellesplace.com

8

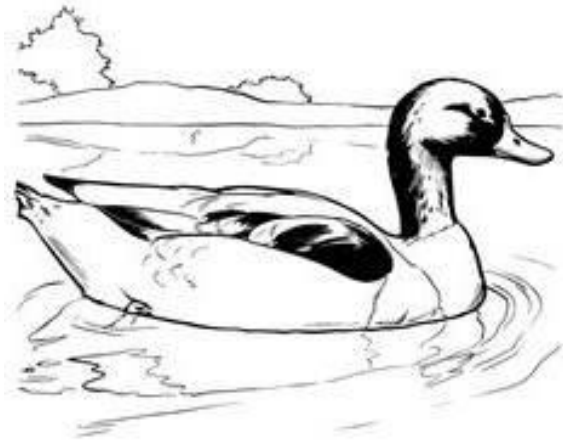

Swim duck swim.

1

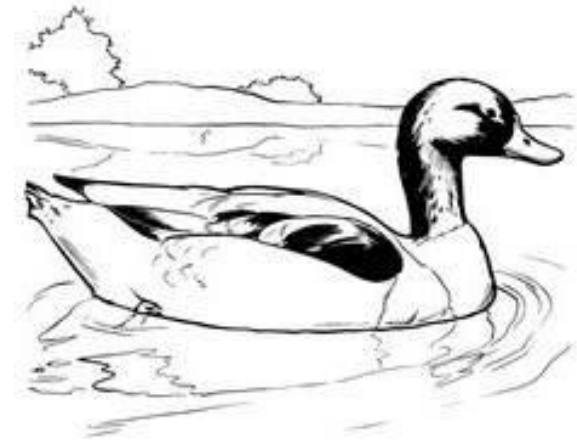

Swim across the pond.

2

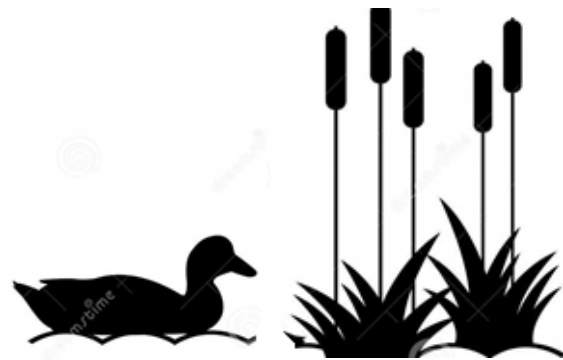

Swim to your babies.

Level 5

3

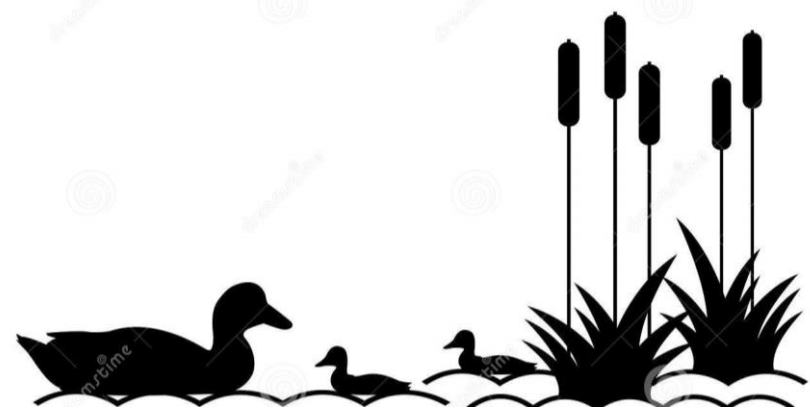

The babies hide in the nest.
They see mother duck.

4



The babies come out of the nest.

5



The ducklings walk with mother duck.

6



The ducklings swim with mother duck.

Level 5

7

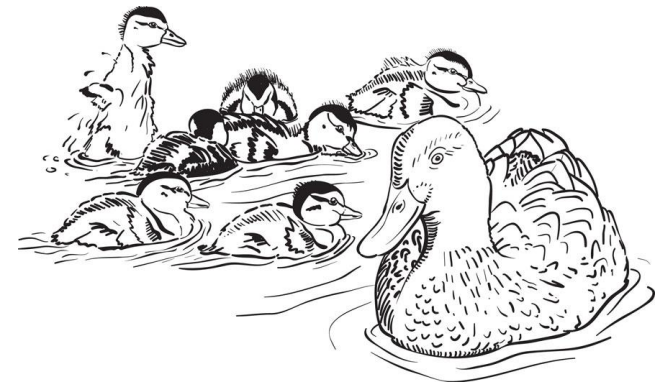

Mother duck looks after her ducklings.

8

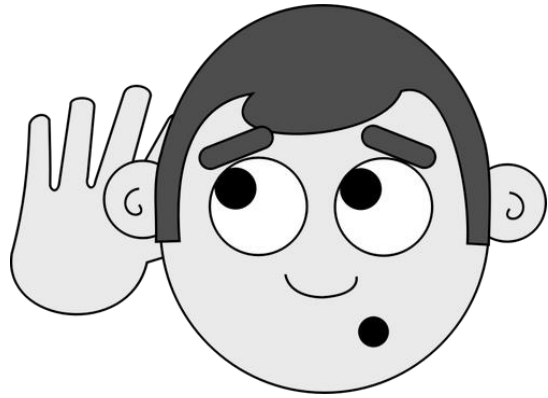

I can hear

Level 5

1

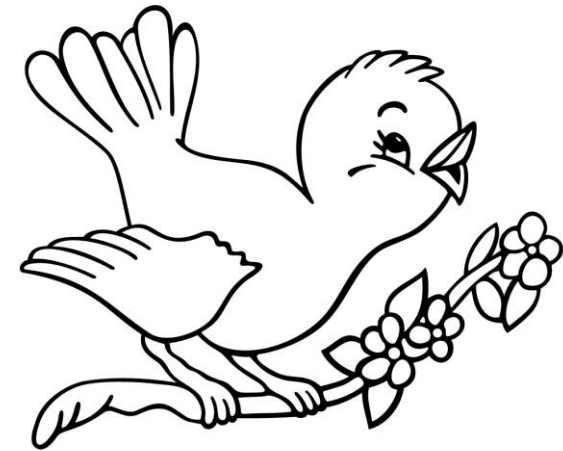

I can hear a bird singing.

2

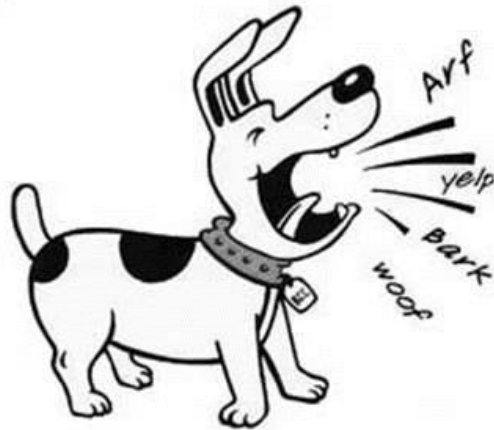

I can hear a dog barking.

3



I can hear a baby crying.

4

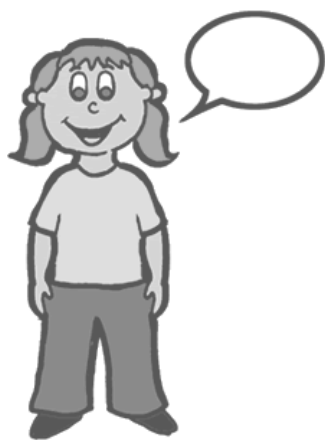

I can hear my friend talking.

5



I can hear children walking.

6



I can hear children playing.

Level 5

7

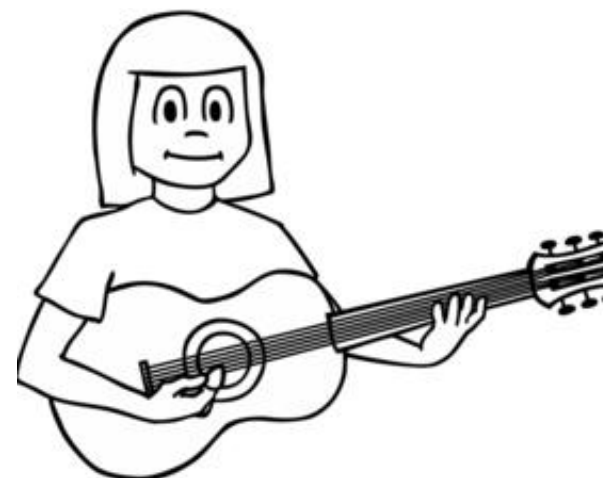

I can hear a guitar playing.

8

Kim's box

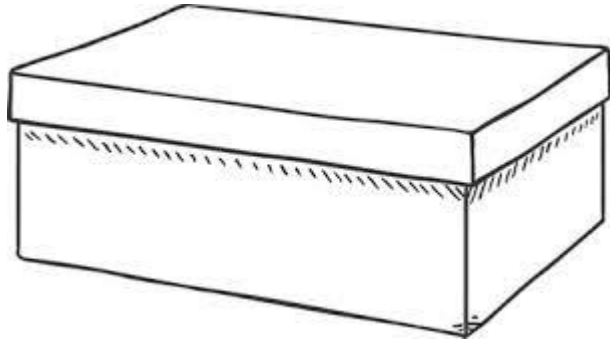

1

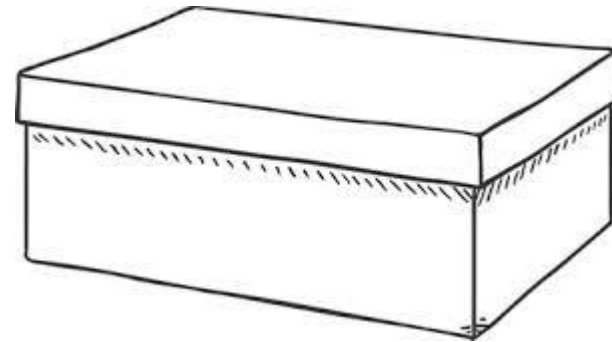

Kim had a big box.
"What do you have in that box?" asked Tom.

2

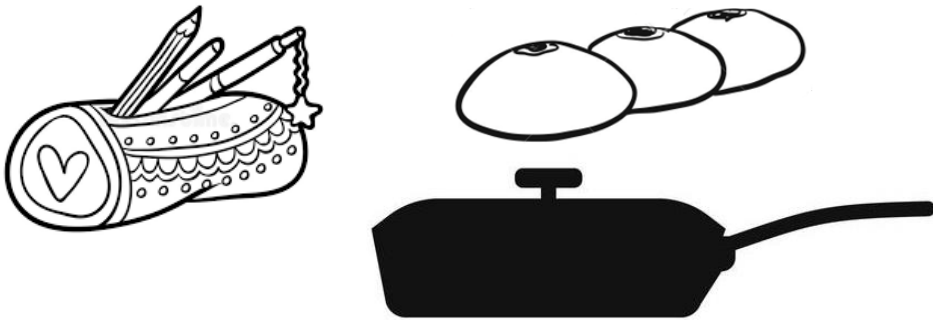

"I have a big bag of pens. I have buns and jam. I have a black pan with a lid.

Level 5

3



I have a red cap and a bag of nuts," said Kim.

"What a big mess!" said Tom.

"No It's not!" said Kim.

4

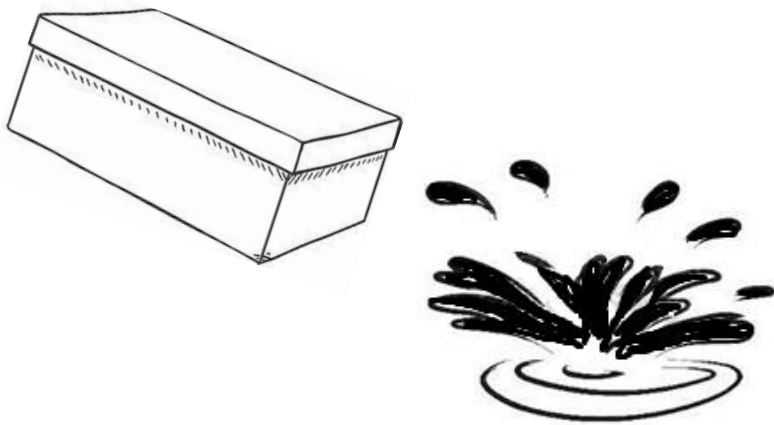

Then the box fell in the mud.
The stuff fell out of the box.
The stuff fell into the mud. It was a
big mess!

5



The buns, nuts and pens fell into the mud.
The black pan with a lid fell into the mud.

6



The red cap fell into the mud.
“What will you do with this stuff?”
asked Tom.

7

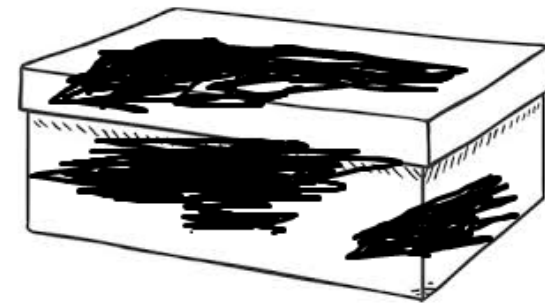

“I will pick it up and put it back in the
box,” said Kim.
That will be very messy,” said Tom.

Level 5

8

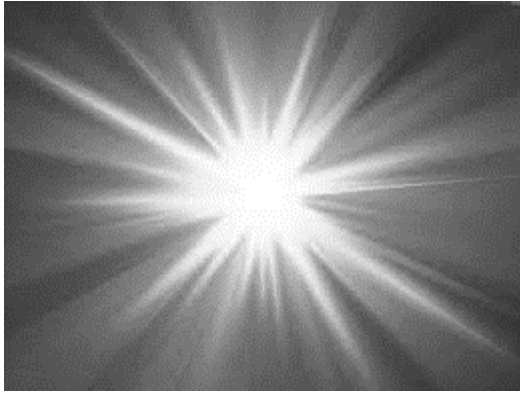

light

1

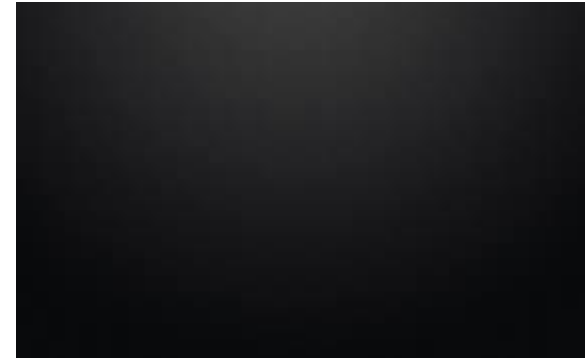

darkness

2

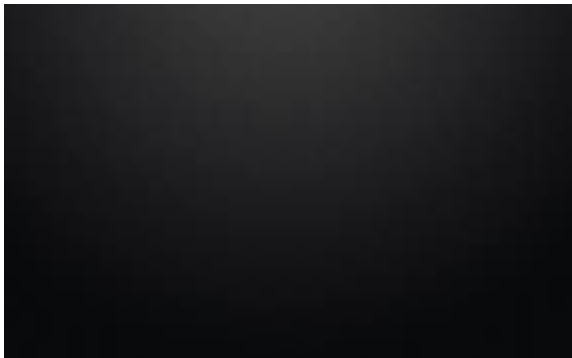

God made darkness.

3

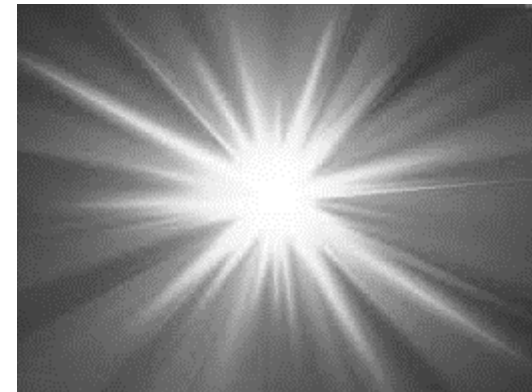

God made light.

Level 5

4

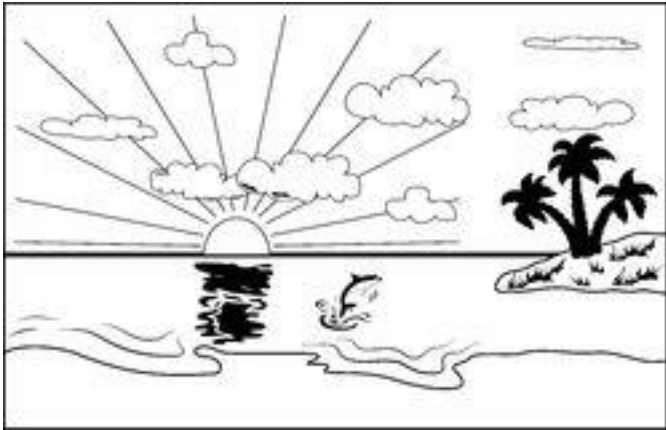

God made day.

5



God made night.

6

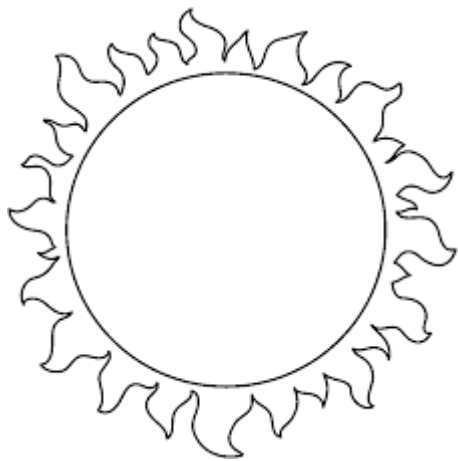

God made the sun. It is a light.

7



God made the moon. It is a light.

Level 5

8

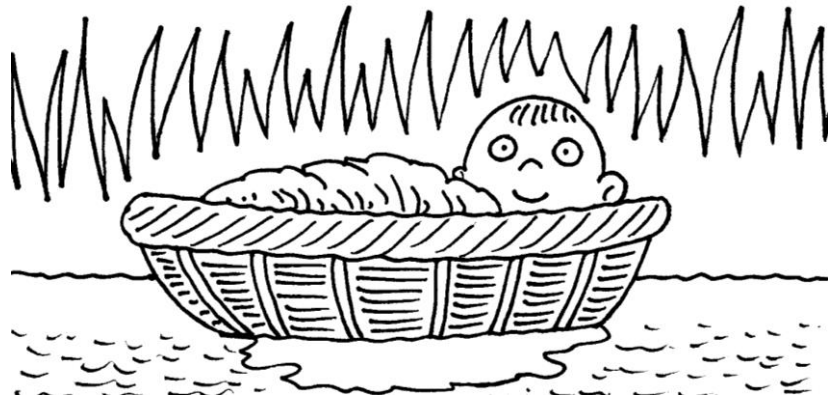

Hide the baby

1



Here is the bad king.

2

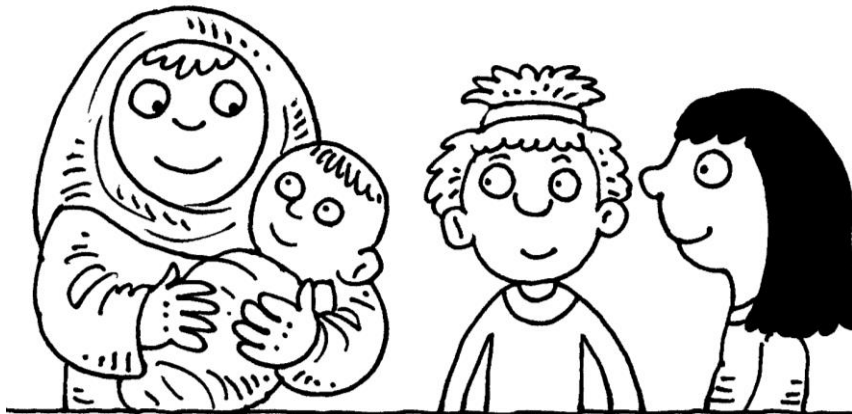

“We must hide the baby,” said Mum.

3



We can make a little boat.

Level 5

4

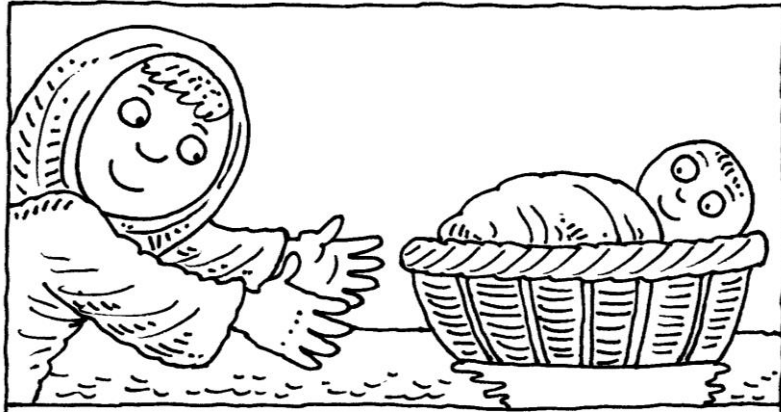

The baby can hide in the boat on the water.

5

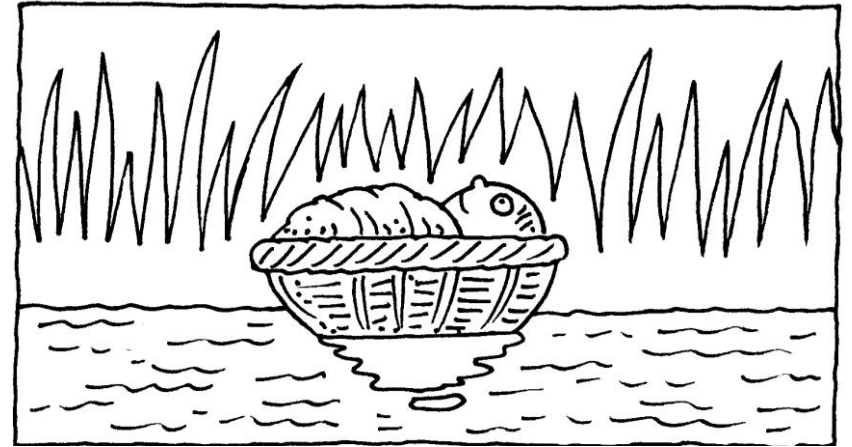

Then the bad king cannot get the baby.

6



Big sister will hide near the water.

7

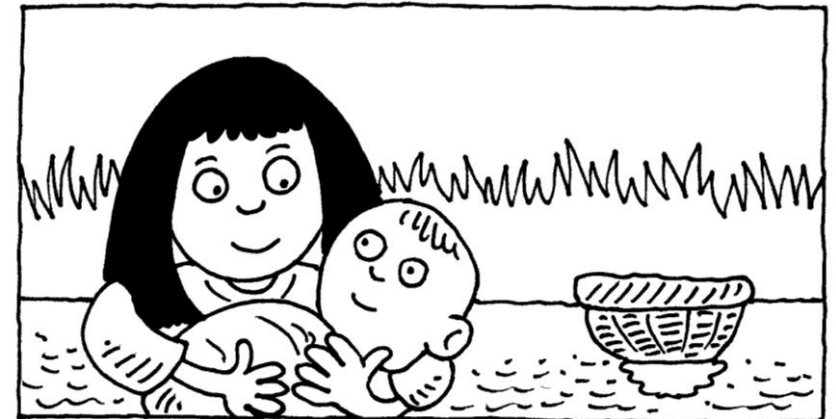

God will be with her.

8

The shepherd boy

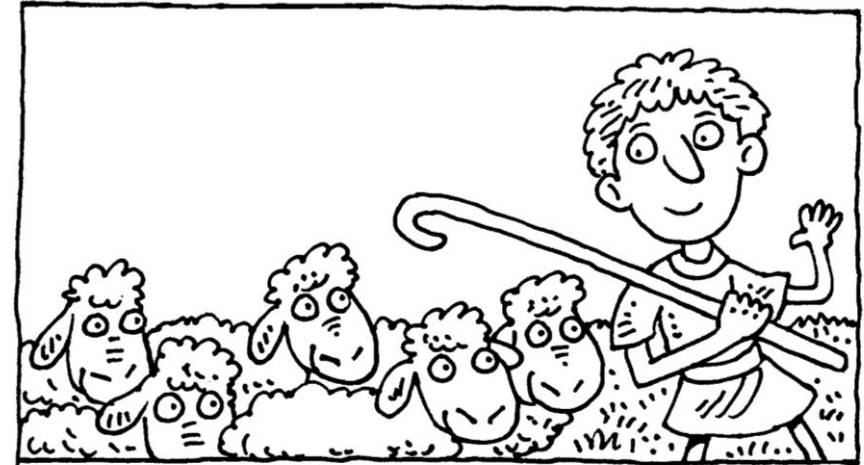
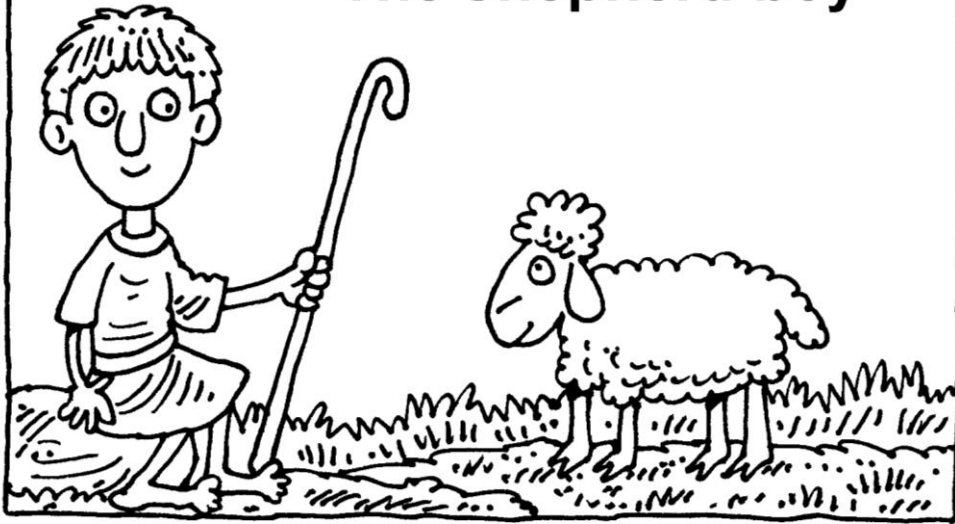

David is a shepherd boy.

2

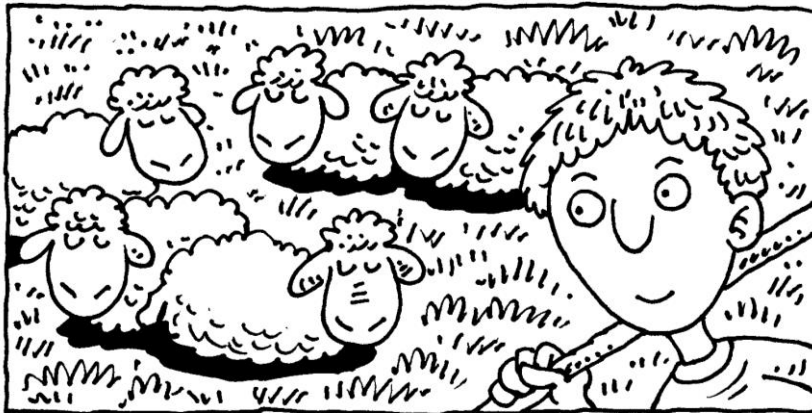

He looks after the sheep.

3



He gives food to the sheep.

4

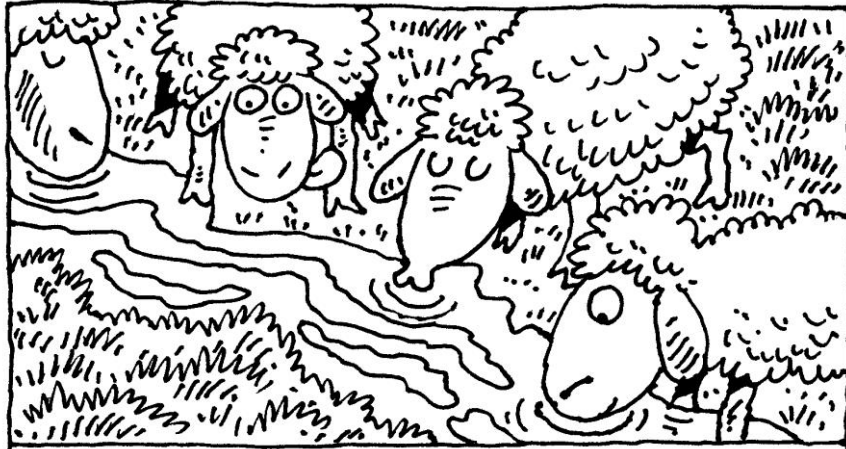

He gives water to the sheep.

5



He gets the sheep if they run off.

6



He loves the sheep.

7



Jesus loves me like a shepherd.

8